

Powered by



# EVX 12260 ▶ 12V 26Ah

EVX 12260 is designed specially for electric vehicles, such as electric golf cart, electric wheelchair, mower, dust collector...etc. It has high cycling life, high efficiency and long service life.



## Specification

|  |   |
|--|---|
| Cells Per Unit                             | 6   |
| Voltage Per Unit                           | 12  |
| Capacity                                   | 26Ah @ 20hr-rate to 1.75V per cell @25 °C (77°F)  |
| Weight                                     | Approx 8.65 kg (19.07lbs)   |
| Maximum Discharge Current                  | 350A(5sec)  |
| Internal Resistance                        | Approx. 11.5 mΩ   |
| Operating Temperature Range                | Discharge: -15°C~50°C ( 5°F~122°F)<br>Charge: -15°C~40°C ( 5°F~104°F)<br>Storage: -15°C~40°C ( 5°F~104°F)   |
| Nominal Operating Temperature Range        | 25°C±3°C (77°F±5°F)   |
| Float Charging Voltage                     | 13.5 to 13.8 VDC/unit Average at 25°C (77°F)  |
| Recommended Maximum Charging Current Limit | 7.8A  |
| Equalization and Cycle Service             | 14.4 to 15.0 VDC/unit Average at 25°C (77°F)  |
| Self Discharge                             | CSB Batteries can be stored for more than 6 months at 25°C (77°F). Please charge batteries before using. For higher temperatures the time interval will be shorter. |
| Terminal                                   | B1/B3/B3B-L terminal to accept M5 bolt  |
| Container Material                         | ABS(UL 94-HB/File E50263)*Flammability resistance of (UL 94-V0/File E88637) can be available upon request.  |



MH14533(N)



ISO9001

No.:041005117



ISO 14001

NO.UM 1-12-0045

CSB-manufactured VRLA batteries are UL-recognized components under UL924 and UL1989.

CSB is also certified by ISO 9001 and ISO 14001.

## Dimensions :

Unit: mm (inch)

|                     |                      |                   |                   |
|---------------------|----------------------|-------------------|-------------------|
| Overall Height (H)  | Container height (h) | Length (L)        | Width (W)         |
| 125±1.5 (4.92±0.06) | 122±1.5 (4.80±0.06)  | 166±2 (6.54±0.08) | 175±2 (6.89±0.08) |

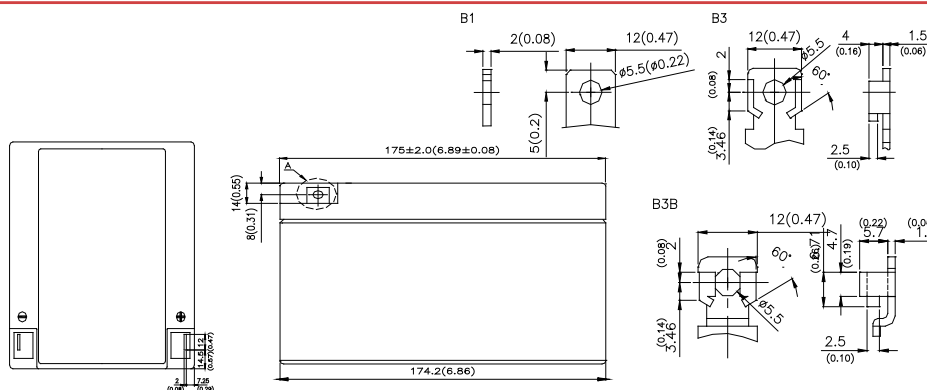
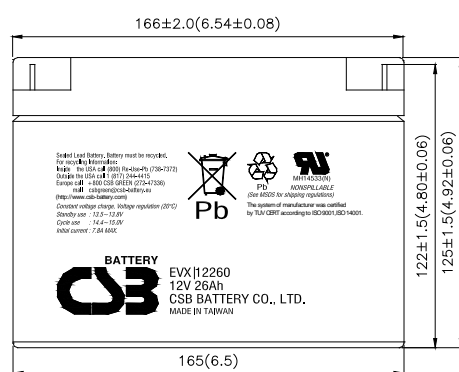

## Constant Current Discharge Characteristics Unit:A (25°C, 77°F)

| F.V/Time | 30MIN | 60MIN | 90MIN | 2HR  | 3HR  | 4HR  | 5HR  | 8HR  | 10HR | 20HR |
|----------|-------|-------|-------|------|------|------|------|------|------|------|
| 1.60V    | 27.3  | 16.5  | 11.8  | 9.54 | 7.03 | 5.66 | 4.68 | 3.18 | 2.63 | 1.44 |
| 1.67V    | 26.5  | 16.0  | 11.4  | 9.22 | 6.82 | 5.49 | 4.56 | 3.09 | 2.56 | 1.41 |
| 1.70V    | 25.7  | 15.5  | 11.1  | 8.97 | 6.59 | 5.32 | 4.43 | 3.00 | 2.48 | 1.37 |
| 1.75V    | 24.9  | 15.0  | 10.8  | 8.68 | 6.39 | 5.16 | 4.30 | 2.91 | 2.40 | 1.33 |
| 1.80V    | 24.1  | 14.6  | 10.4  | 8.41 | 6.19 | 5.00 | 4.16 | 2.81 | 2.32 | 1.28 |
| 1.85V    | 23.3  | 14.1  | 10.1  | 8.13 | 5.99 | 4.84 | 4.03 | 2.72 | 2.24 | 1.24 |

## Constant Power Discharge Characteristics Unit:W (25°C, 77°F)

| F.V/Time | 30MIN | 60MIN | 90MIN | 2HR  | 3HR  | 4HR  | 5HR  | 8HR  | 10HR | 20HR |
|----------|-------|-------|-------|------|------|------|------|------|------|------|
| 1.60V    | 328   | 198   | 141   | 114  | 84.3 | 67.9 | 56.2 | 38.2 | 31.5 | 17.3 |
| 1.67V    | 318   | 192   | 137   | 111  | 81.4 | 65.7 | 54.6 | 37.2 | 30.6 | 16.9 |
| 1.70V    | 308   | 186   | 133   | 107  | 79.1 | 63.8 | 53.2 | 36.0 | 29.7 | 16.4 |
| 1.75V    | 299   | 181   | 129   | 104  | 76.7 | 61.9 | 51.6 | 34.9 | 28.8 | 15.9 |
| 1.80V    | 289   | 175   | 125   | 101  | 74.3 | 60.0 | 49.9 | 33.7 | 27.8 | 15.4 |
| 1.85V    | 280   | 170   | 121   | 97.1 | 71.9 | 58.1 | 48.3 | 32.6 | 26.9 | 14.9 |

### Trickle (or Float) Service Life

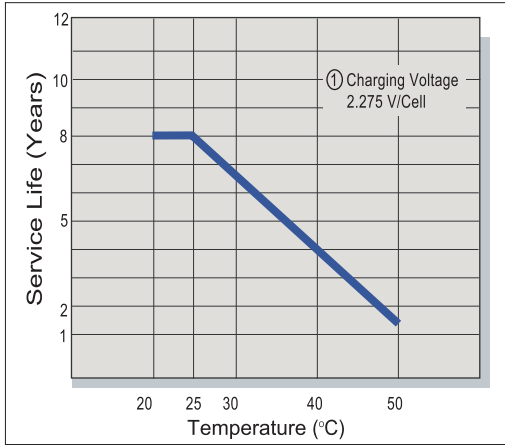

### Capacity Retention Characteristic

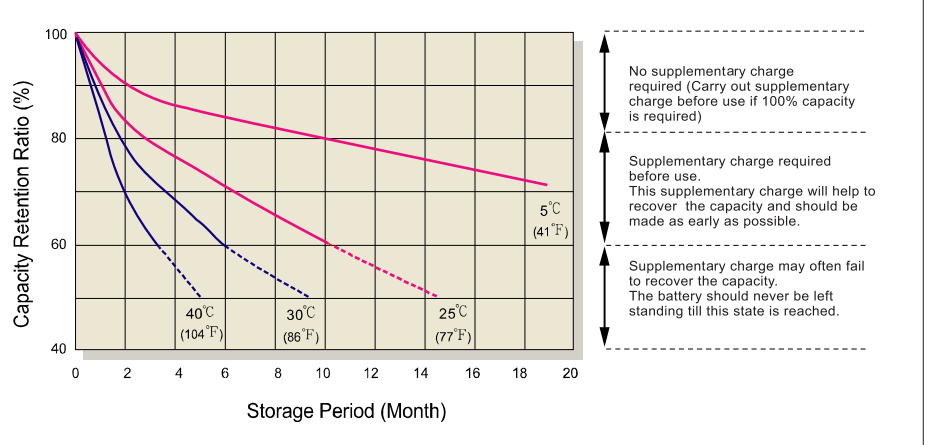

### Battery Voltage and Charge Time for Standby Use

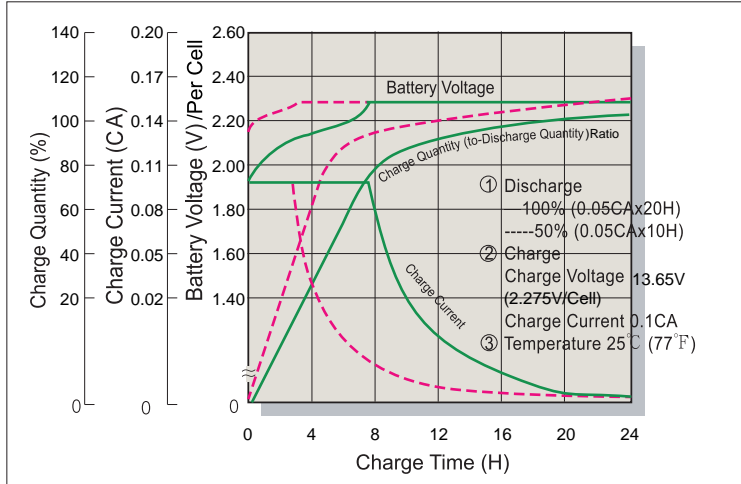

### Series Cycle Service Life

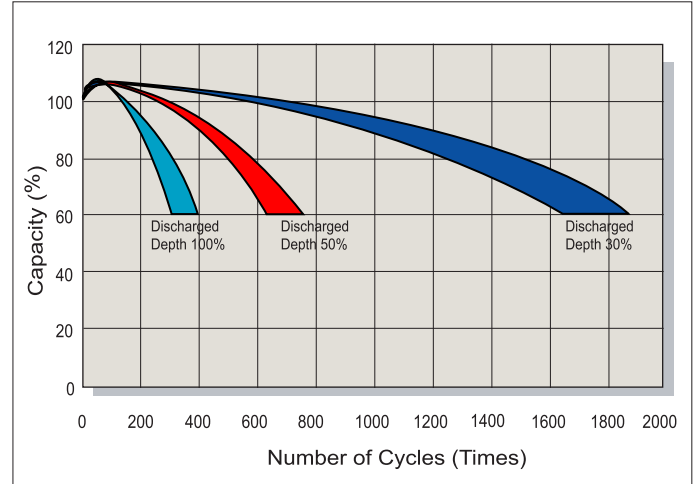

### Battery Voltage and Charge Time for Cycle Use

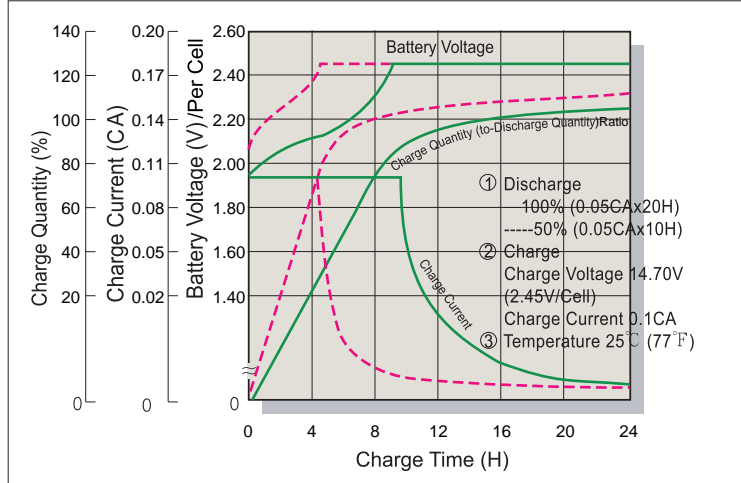

### Terminal Voltage (V) and Discharge Time

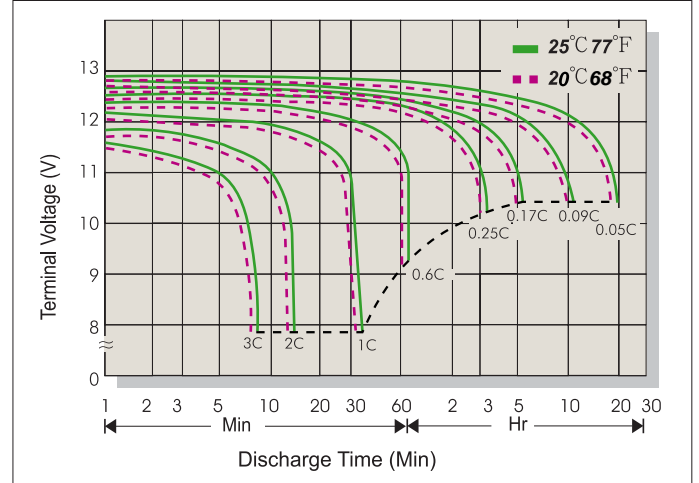

### Charging Procedures

| Application | Charge Voltage(V/Cell) |           |                 | Max.Charge Current |
|-------------|------------------------|-----------|-----------------|--------------------|
|             | Temperature            | Set Point | Allowable Range |                    |
| Cycle Use   | 25°C(77°F)             | 2.45      | 2.40~2.50       | 0.3C               |
| Standby     | 25°C(77°F)             | 2.275     | 2.25~2.30       |                    |

### Discharge Current VS. Discharge Voltage

|                                |          |               |               |          |
|--------------------------------|----------|---------------|---------------|----------|
| Final Discharge Voltage V/Cell | 1.75     | 1.70          | 1.60          | 1.30     |
| Discharge Current(A)           | 0.2C>(A) | 0.2C<(A)<0.5C | 0.5C<(A)<1.0C | (A)>1.0C |

Sales Office URL: [WWW.CSB-BATTERY.COM](http://WWW.CSB-BATTERY.COM)

**Distribution Deutschland**  
 ZDIS GmbH  
 Tel : +49 (0)8638-981 606-0  
 Fax : +49 (0)8638-981 606-9  
 mail : [vertrieb@zdis.de](mailto:vertrieb@zdis.de)

**BEIJING OFFICE. (CHINA)**  
**CSB BATTERY TECHNOLOGIES (BEIJING) CO., LTD.**  
 Tel : +86-10-59621300/1301/1302/1303  
 Fax : +86-10-59621304  
 mail : [chinasls@csb-battery.com](mailto:chinasls@csb-battery.com)

**AMERICA HQ**  
**CSB BATTERY TECHNOLOGIES INC. (U.S.A)**  
 Tel : +1-817-244-7777/1-(800)3-CSB-USA(272872)  
 Fax : +1-817-244-4445  
 mail : [csb@csb-battery.com](mailto:csb@csb-battery.com)

**SHANGHAI OFFICE. (CHINA)**  
**CSB BATTERY LOGISTIC (SHANGHAI) CO., LTD.**  
 Tel : +86-21-5046-1622/5046-0833  
 Fax : +86-21-5064-3314  
 mail : [chinasls@csb-battery.com](mailto:chinasls@csb-battery.com)

**EUROPE HQ**  
**CSB Battery Europe BV.**  
 Tel : +31(0)-180-418-140  
 Fax : +886-2-2555-3300  
 mail : [eurossales@csb-battery.eu](mailto:eurossales@csb-battery.eu)

**SHENZHEN OFFICE. (CHINA)**  
**CSB BATTERY LOGISTIC (SHANGHAI) CO., LTD.**  
 Tel : +86-755-8831-6488/6396/6356  
 Fax : +86-755-8831-6548  
 mail : [she@csb-battery.com.cn](mailto:she@csb-battery.com.cn)